



BRITANNIA METADOR

— STEEL DOORS —



Metador Defender.
The best steel door system
on the market *

Here's the small print:

* It's true - our customers keep telling us!

Metador Defender

Why it's the best steel door system for you...

"My Client has praised the quality of the product (Defender Doors) which has led to an order for 3 more doors to replace on site."

D.I., Installation Company



Metador Defender has bolted corners.
Stronger for your customers - and quicker for you.

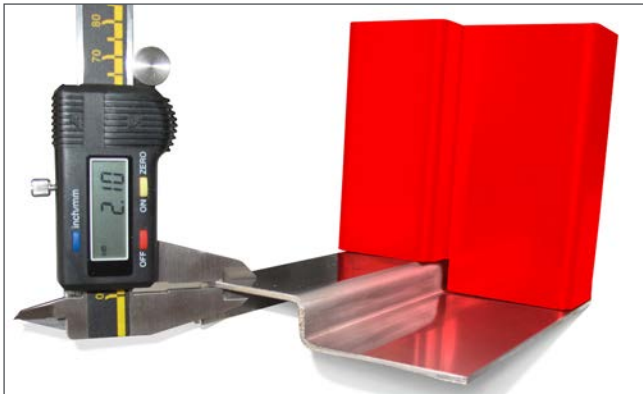

Metador Defender has a 2mm stainless steel threshold.

If it skimps on materials - it's not Metador.



Metador Defender has a high insulation mineral wool core as standard.

Ever wondered how a door with a cardboard honeycomb core can give the insulation your customer wants? It doesn't.



Metador Defender is manufactured from galvanised material throughout.
Never from Zintec or Galvaneal.



Metador Defender has 1.5mm leaf skins.
That's 56% stronger than the standard 1.2mm.

Metador Defender has 16 threaded adjusters as standard - 8 fixing points each side of the door.

4 grade 13 stainless steel hinges with dog bolts.

Metador Defender is certified to international standards.

- CE Marked
- ISO 9001:2008
- CERIBOIS thermally rated to 1.8Wm²K
- BS EN 1634-1:2008 Fire Rating Test





Why it's the best for your customers...

When your customers need doors, they often need them in a hurry. Long lead times are unhelpful for your customers, and can so easily damage your reputation. With the Defender modular construction, we can make up doorsets of any width from 340mm upwards within 1-3 days, allowing you to give a service that exceeds your customers' wildest expectations.

And your customers not only get a great service, they get a superb product.



A set of sub-assemblies for a complete Metador Defender door system

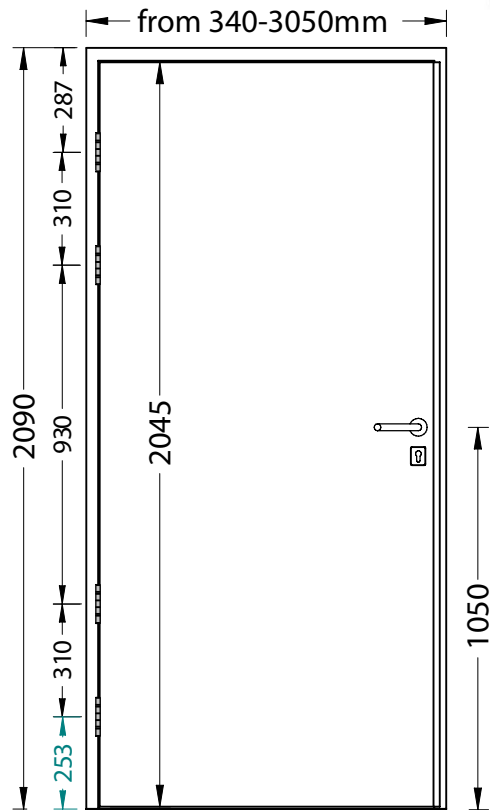

Outward Opening

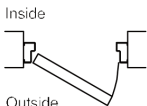

Left Hand Hinged (LH)

Inward Opening

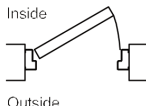

Right Hand Hinged (RH)

Outward Opening



Left Hand Hinged (LH)

Inward Opening

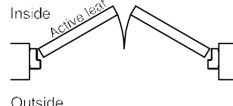

Right Hand Hinged (RH)

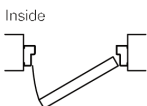

Right Hand Hinged (RH)

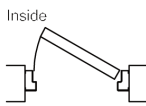

Left Hand Hinged (LH)



Right Hand Hinged (RH)

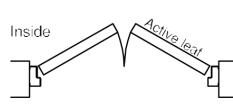

Left Hand Hinged (LH)

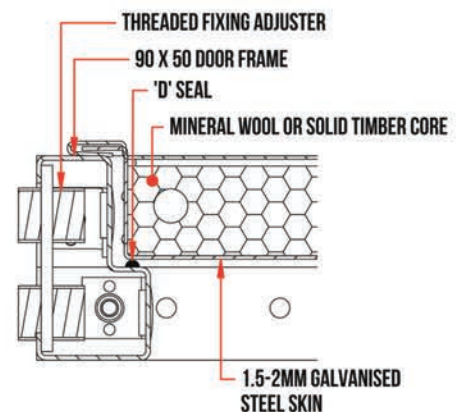

A successful partnership

Learn more about how you can be a part of the Metador Defender success story - talk to Britannia Metador. And very soon, your customers will be telling you:

'Metador Defender is the best steel door system on the market!'

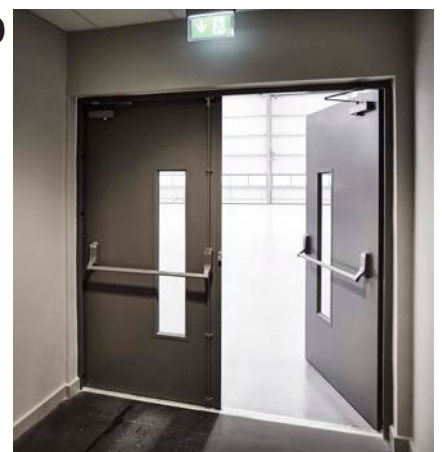

Britannia Metador

Established in 2004, Britannia Metador has become one of the UK's leading steel door manufacturers.

Having amassed a wealth of knowledge in design, manufacture and installation of security products, we could see that the market needed a completely new approach to steel door systems.

A champion is born

After an exhaustive research and development programme, in 2012 the Metador Defender was born. Promising to shatter the quality issues and time constraints of standard steel doors, Defender was an immediate success.

Opening doors for your business

Alongside this world-beating product, Britannia Metador has built an enviable reputation for quality products, on-time delivery, and the endearing habit of looking after our customers.

Contact us

To talk about what we can do for your business, call us now. Or print the enquiry form on the next page and send it to us.

01642 337 119

security@britanniametador.com



Britannia Metador
Britannia House
John Boyle Road
Middlesbrough
TS6 6TY
UK

+44 (0)1642 337 119
www.britanniametador.com



**BRITANNIA
METADOR**
— STEEL DOORS —

Opening doors for your business



Metador enquiry form

Need a door? Fill out this form and send to us for a no-obligation free quotation.

Quantity:	Date:
Structural Opening Width:	Company Name:
Structural Opening Height:	Address:
Colour:	
Hardware:	
	Telephone No:
	Email:

Handing:

Outward Opening

Inside

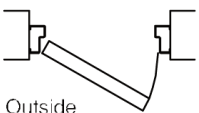

Outside

Left Hand Hinged (LH)

Inward Opening

Inside



Outside

Right Hand Hinged (RH)

Outward Opening

Inside



Outside

Left Hand Hinged (LH)

Inward Opening

Inside

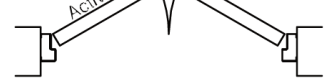

Outside

Right Hand Hinged (RH)

Inside

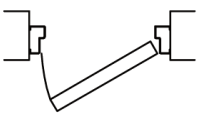

Outside

Right Hand Hinged (RH)

Inside

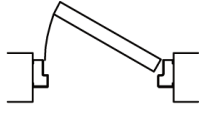

Outside

Left Hand Hinged (LH)

Inside



Outside

Right Hand Hinged (RH)

Inside



Outside

Left Hand Hinged (LH)

Drawing (Optional):

Other Comments/Details:

Simply print this form, fill it in (with as much detail as possible), scan it and email to:

security@britanniametador.com

Or fax to: **0845 371 0404** - or talk to us on: **01642 337 119**